



# PF728

## INSTRUCTION MANUAL

### Contents

Warnings and Precautions .....	2
Important Safety Instructions.....	3
In the Box & Changing the Remote Battery.....	4
Powering the Unit & Compatible Storage Devices .....	5
Viewing Photos.....	6
Playing Music .....	7
Viewing Photos & Playing Music .....	8
Setting the Time and Date & Setting the Alarm .....	9
Taking a Frame Off & Putting a Frame On .....	10-11
Location of Controls & Control Definitions.....	12-15
Service Information.....	16

# Warnings and Precautions

---

**TO PREVENT FIRE OR SHOCK HAZARDS, DO NOT EXPOSE THIS UNIT TO RAIN OR MOISTURE.**



This symbol, located on back or bottom of the unit, is intended to alert the user to the presence of uninsulated “dangerous voltage” within the product’s enclosure that may be of sufficient magnitude to constitute a risk of electric shock to persons.



This symbol, located on back or bottom of the unit, is intended to alert the user to the presence of important operating and maintenance (servicing) instructions in the literature accompanying the appliance.

**CAUTION:** TO PREVENT ELECTRIC SHOCK, MATCH WIDE BLADE OF PLUG TO WIDE SLOT, FULLY INSERT.

To reduce the risk of electric shock, do not remove cover (or back). There are no user-serviceable parts inside. Please refer any servicing to qualified service personnel.

**WARNING:** Changes or modifications to this unit not expressly approved by the party responsible for compliance could void the user’s authority to operate the equipment.

**WARNING:** Danger of explosion if the remote control’s batteries are incorrectly installed. Replace only with the same or equivalent battery.

**WARNING:** The remote control’s button cell battery contains mercury. Do not put in the trash, instead recycle or dispose of as hazardous waste

**WARNING:** Use of this unit near fluorescent lighting may cause interference regarding use of the remote. If the unit is displaying erratic behavior move away from any fluorescent lighting, as it may be the cause.

NOTE: This equipment has been tested and found to comply with the limits for a Class B digital device, pursuant to Part 15 of the FCC Rules. These limits are designed to provide reasonable protection against harmful interference in a residential installation. This equipment generates, uses, and can radiate radio frequency energy and, if not installed and used in accordance with the instructions, may cause harmful interference to radio communications. However, there is no guarantee that interference will not occur in a particular installation. If this equipment does cause harmful interference to radio or television reception, which can be determined by turning the equipment off and on, the user is encouraged to try to correct the interference by one or more of the following measures:

- Reorient or relocate the receiving antenna.
- Increase the separation between the equipment and receiver.
- Connect the equipment into an outlet on a circuit different from that to which the receiver is connected.
- Consult the dealer or an experienced radio/TV technician for help.

# Important Safety Instructions

**1. Read these instructions.** All the safety and operating instruction should be read before the product is operated.

**2. Keep these instructions.** The safety and operating instruction should be retained for future reference.

**3. Heed all warnings.** All warning on the product and in the operating instructions should be adhered to.

**4. Follow all instructions.** All operating and use instructions should be followed.

**5. Water and Moisture:** Do not use this product near water - for example, near a bath tub, wash bowl, kitchen sink, or laundry tub; in a wet basement, or near a swimming pool, and the like. The apparatus shall not be exposed to dripping or splashing and that no objects filled with liquids, such as vases, shall be placed on apparatus.

**6. Cleaning:** Clean only with a dry cloth. Unplug this product from the wall outlet before cleaning. Do not use liquid cleaners or aerosol cleaners.

**7. Ventilation:** Slots and openings in the cabinet are provided for ventilation and to ensure reliable operation of the product and to protect it from overheating, and these openings must not be blocked or covered. The openings should never be blocked by placing the product on a bed, sofa, rug, or other similar surface. This product should not be placed in a built-in installation such as a bookcase or rack unless proper ventilation is provided or the manufacturer's instructions have been adhered to.

**8. Heat:** Do not install near any heat sources such as radiators, heat registers, stoves, or other apparatus (including amplifiers) that produce heat.

**9. Grounding or Polarization:** Do not defeat the safety purpose of the polarized or grounding-type plug. A polarized plug has two blades with one wider than the other. A grounding type plug has two blades and a third grounding prong. The wide blade or the third prong are provided for your safety. If the provided plug does not fit into your outlet, consult an electrician for replacement of the obsolete outlet.

**10. Power-Cord Protection:** Protect the power cord from being walked on or pinched particularly at plugs, convenience receptacles, and the point where they exit from the apparatus.

**11. Accessories:** Only use attachments/accessories specified by the manufacturer. Do not place this product on an unstable cart, stand tripod, bracket, or table. The

product may fall, causing serious injury to a child or adult, and serious damage to the product. Use only with a cart, stand, tripod, bracket, or table recommended by the manufacturer, or sold with the product. Any mounting of the product should follow the manufacturer's instructions, and should use a mounting accessory recommended by the manufacturer.

**12.** A product and cart combination should be moved with care. Use only with the cart, stand, tripod, bracket, or table specified by the manufacturer, or sold with the apparatus. When a cart is used, use caution when moving the cart/apparatus combination to avoid injury from tip-over.



PORTABLE  
CART  
WARNING

S3125A

**13. Lighting:** Unplug this apparatus and disconnect the antenna or cable system during lightning storms or when unused for long periods of time. This will prevent damage to the product due to lightning and power-line surges.

**14. Servicing:** Do not attempt to service this product yourself as opening or removing covers may expose you to dangerous voltage or other hazards. Refer all servicing to qualified service personnel.

**15. Power Sources:** Only connect to the type of house-hold power supply as indicated in the operating instructions and rating label. If you are not sure of the type of power supply to your home, consult your product dealer or local power company. For products intended to operate from battery power, or other sources, refer to the operating instruction.

**16. Overloading:** Do not overload wall outlets or extension cords as this can result in a risk of fire or electric shock.

**17. Object and Liquid Entry:** Never push objects of any kind or spill liquid into this product through openings as this could result in a risk of fire or electric shock.

**18. Replacement Parts and Safety Check:** When replacement parts are required, be sure the service technician has used replacement parts specified by the manufacturer. Ask the service technician to perform safety checks to ensure proper operation to avoid possible fire, electric shock, or other hazards.

**19. Outdoor Antenna Grounding:** If an outside antenna or cable system is connected to the product, be sure the antenna or cable system is grounded so as to provide some protection against voltage surges and built-up static charges. Article 810 of the National Electrical Code, ANSI/NFPA 70, provides information with regard to proper grounding of the mast and supporting structure, grounding of the lead-in wire to an antenna connection to grounding electrodes, and requirements for the grounding electrode.

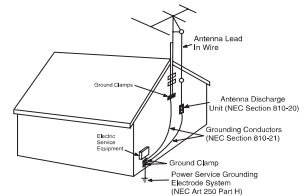

**20. Wall or Ceiling Mounting:** The product should be mounted to a wall or ceiling only as recommended by the manufacturer.

**21.** Where the AC plug or an appliance coupler is used as the disconnect device, the disconnect device shall remain readily operable.

**22. Protective Attachment Plug:** The product is equipped with an attachment plug having overload protection. This is a safety feature. See Instruction Manual for replacement or resetting of protective device. If replacement of the plug is required, be sure the service technician has used a replacement plug specified by the manufacturer that has the same overload protection as the original plug.

**23. Power Lines:** An outside antenna system should not be located in the vicinity of overhead power lines or other electric light or power circuits, or where it can fall into such power lines or circuits. When installing an outside antenna system, extreme care should be taken to keep from touching such power lines or circuits as contact with them might be fatal.

## In the Box

---

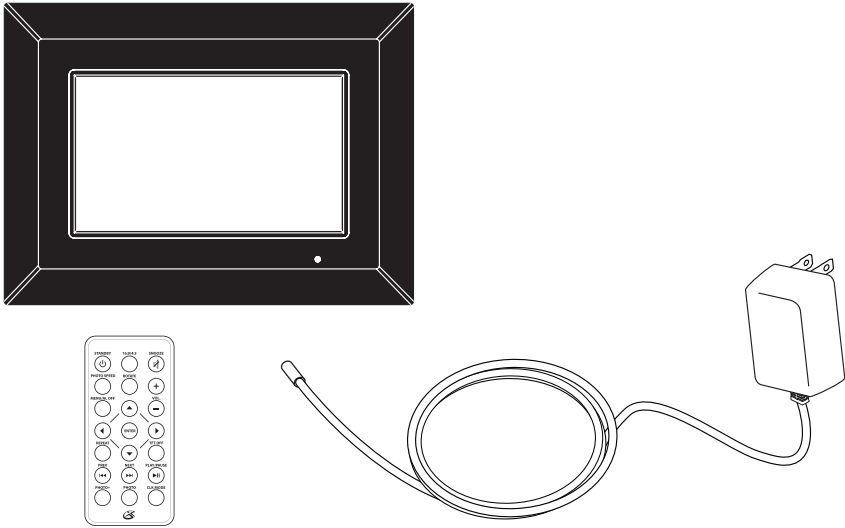

- Digital Photo Frame
- AC/DC Adapter
- Remote Control
- Documentation

## Changing the Remote Battery

---

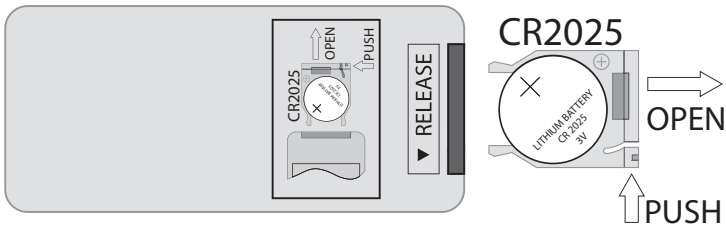

1. Push to remove the Battery Compartment cover.
  2. Replace the old battery with an equivalent new battery (CR2025).
  3. The positive side of the battery, as indicated by a plus symbol, must be facing up when inserted into the remote.
-

## Powering the Unit

---

To power the unit, simply connect it to an AC outlet using the included AC adapter.

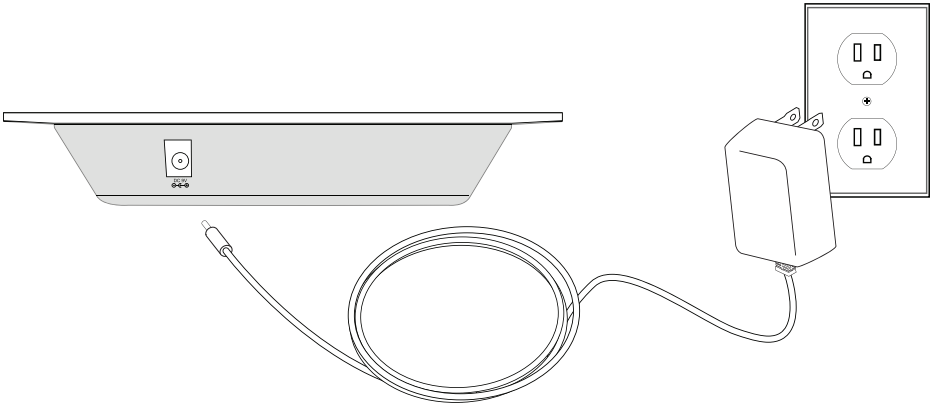

## Compatible Storage Devices

---

The following types of digital storage devices can be connected to the unit to play photos and music on the unit.

USB Mass Storage Device  
(not included)

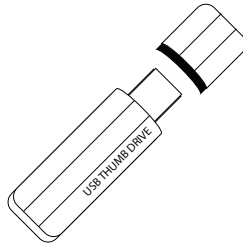

Memory Cards  
(not included)

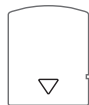

XD



MS



MMC

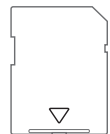

SD

## Viewing Photos

---

1. Connect a XD, MS, MMC, or SD memory card, or a USB Thumb Drive, to the unit.

*The memory card or thumb drive that is connected to the unit must have jpeg images loaded onto it.*

2. Press the **Power/Snooze Button** to turn the unit on.
  3. Press the **Menu/AL Off Button** twice to access the unit's main menu.
  4. Press the **Left** and **Right Buttons** to navigate and highlight the options on the main menu (Card, USB, Favorite, Clock, Calendar, and Setup)
  5. To access photos from a loaded memory card, select the Card option. To access photos from a connected USB thumb drive, select the USB option. To view pre-loaded photos on the digital photo frame, select the Favorite option.
  6. Press the **Enter/Mode Button** to select Card, USB, or Favorite.
  7. Highlight *Photo* and press the **Enter/Mode Button** to select the photo option.
  8. Photos from the connected memory source (XD card, MS card, MMC card, SD card, or USB Thumb Drive) will now play as a slideshow on the unit.
-

## Playing Music

---

1. Connect a XD, MS, MMC, or SD memory card, or a USB Thumb Drive, to the unit.

*The memory card or thumb drive that is connected to the unit must have jpeg images loaded onto it.*

2. Press the **Power/Snooze Button** to turn the unit on.
  3. Press the **Menu/AL Off Button** twice to access the unit's main menu.
  4. Press the **Left** and **Right Buttons** to navigate and highlight the options on the main menu (Card, USB, Favorite, Clock, Calendar, and Setup)
  5. To access music from a loaded memory card, select the Card option. To access music from a connected USB thumb drive, select the USB option.
  6. Press the **Enter/Mode Button** to select Card, or USB.
  7. Highlight *Music* and press the **Enter/Mode Button** to select the music option.
  8. Music from the connected memory source (XD card, MS card, MMC card, SD card, or USB Thumb Drive) will now play from the unit.
-

## Viewing Photos & Playing Music

---

1. Connect a XD, MS, MMC, or SD memory card, or a USB Thumb Drive, to the unit.

*The memory card or thumb drive that is connected to the unit must have jpeg images loaded onto it.*

2. Press the **Power/Snooze Button** to turn the unit on.
  3. Press the **Menu/AL Off Button** twice to access the unit's main menu.
  4. Press the **Left** and **Right Buttons** to navigate and highlight the options on the main menu (Card, USB, Favorite, Clock, Calendar, and Setup)
  5. To access music and photos from a loaded memory card, select the Card option. To access music and photos from a connected USB thumb drive, select the USB option.
  6. Press the **Enter/Mode Button** to select Card, or USB.
  7. Highlight *Photo+* and press the **Enter/Mode Button** to select the photo and music option.
  8. Photos and music from the connected memory source (XD card, MS card, MMC card, SD card, or USB Thumb Drive) will now play on the unit.
-



## Setting the Time and Date

---

1. Press the **Power/Snooze Button** to turn the unit on.
2. Press the **Menu/AL Off Button** twice to access the unit's main menu.
3. Press the **Left** and **Right Buttons** to navigate and highlight the options on the main menu (Card, USB, Favorite, Clock, Calendar, and Setup)
4. Highlight the *Setup* option and press the **Enter/Mode Button**.
5. Press the **Volume Buttons** to move down through the setup menu.
6. Highlight *Time Set*, then press the **Left** and **Right Buttons** to highlight the date and time. Once highlighted, press the **Volume Buttons** to edit the date and time.
7. After the correct date and time are entered, press the **Menu/AL Off Button** to return to the main menu.

## Setting the Alarm

---

1. Press the **Power/Snooze Button** to turn the unit on.
2. Press the **Menu/AL Off Button** twice to access the unit's main menu.
3. Press the **Left** and **Right Buttons** to navigate and highlight the options on the main menu (Card, USB, Favorite, Clock, Calendar, and Setup)
4. Highlight the *Setup* option and press the **Enter/Mode Button**.
5. Press the **Volume Buttons** to move down through the setup menu.
6. Highlight *Alarm Set*, then press the **Left** and **Right Buttons** to highlight the alarm time. Once highlighted, press the **Volume Buttons** to edit the alarm time.
7. Highlight and adjust between Ring1 and Ring2, and turn the alarm On or Off.
8. After the correct alarm time is set, press the **Menu/AL Off Button** to return to the main menu.

## Taking a Frame Off

---

1. Lay the unit down on a flat surface, with the display facing upward.
2. Place a soft cotton cloth over the display. This will keep the display clean of finger prints while changing the frame.
3. Put your thumbs just inside the frame, over the cloth covered display.
4. Gently apply upward pressure on the outside lip of the frame using your fingers.

*Do not apply pressure to the display to keep from damaging the unit.*

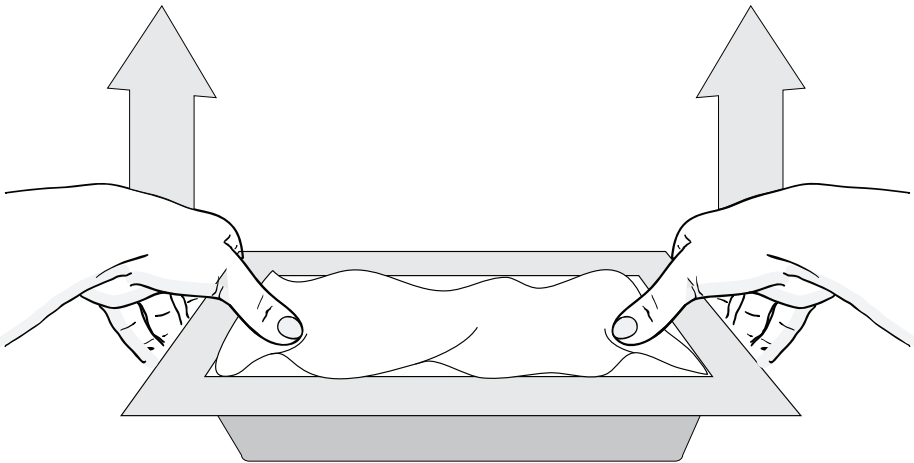

## Putting a Frame On

---

5. Remove the soft cotton cloth that was used in step 2 so that it does not get in the way.
6. Match the engraved up arrow on the inside of the frame with the top of the unit. Match the small clear window on the frame with the infrared receiver on the unit.

*If the small clear window on the frame is not matched up with the infrared receiver on the unit, the unit will not respond to the remote control.*

7. Gently push the frame onto the unit, matching the small pegs on the frame with the holes on the unit without touching the display.

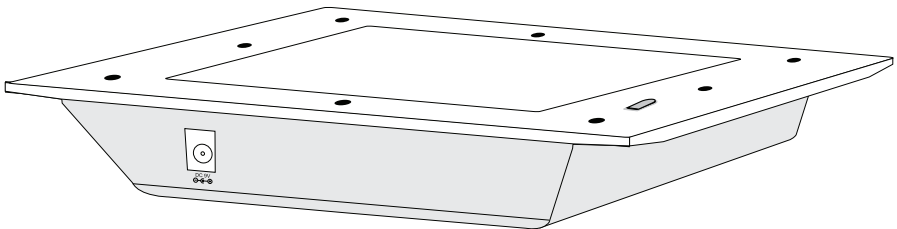
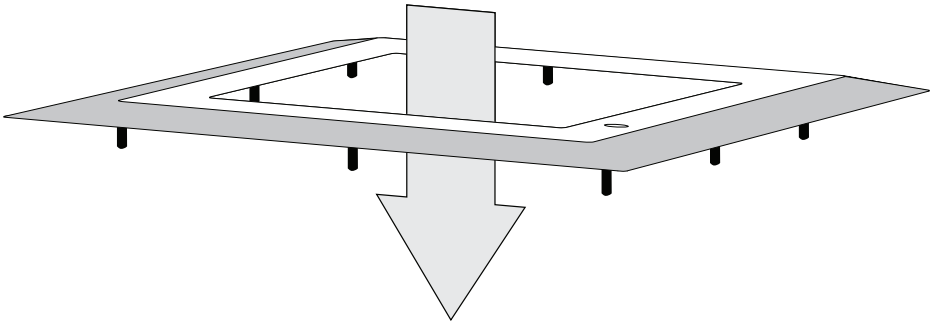

# Location of Controls

---

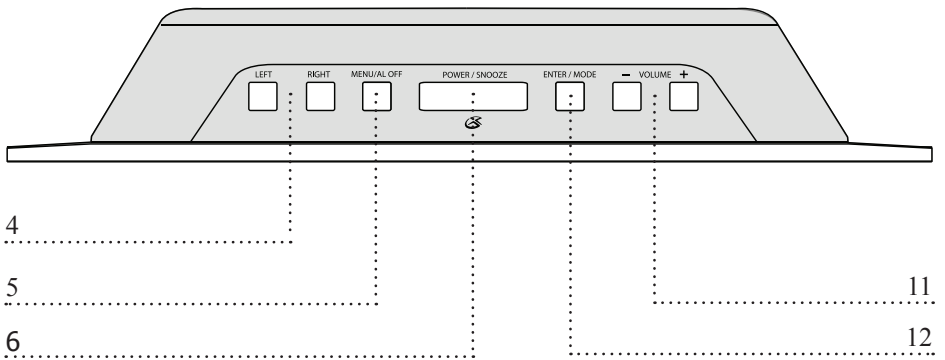
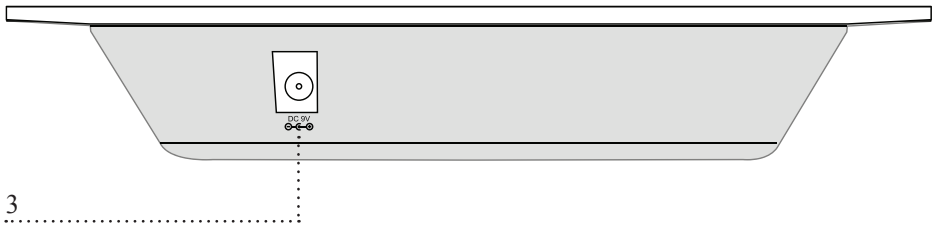
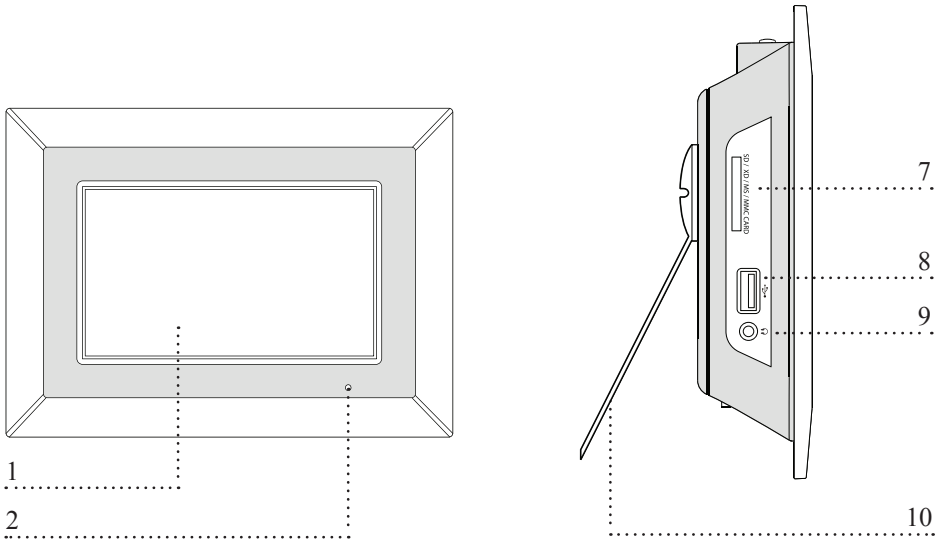

## Control Definitions

---

### **1 TFT Display**

The TFT Display displays the unit's menus and photos.

---

### **2 Infrared Receiver**

The Infrared Receiver receives signals from the remote control.

---

### **3 DC Input**

Connect the DC Input to power the unit.

---

### **4 Left/Right Buttons**

Use the Left/Right Buttons to navigate the unit's menus.

---

### **5 Menu/AL Off Button**

Press the Menu Button to go back to the Main Menu. Press the AL Off Button to turn the alarm off after it sounds.

---

### **6 Power/Snooze Button**

Press the Power Button to turn the unit off and on. Press the Snooze Button to delay the alarm for 6 minutes after it sounds.

---

### **7 SD/XD/MS/MMC Card Slot**

Insert a compatible memory card into the SD/XD/MS/MMC Card Slot to play photos, videos and audio files from the memory card. You can also transfer photos from a memory expansion card to the photo frame's internal memory by selecting the Copy option in the main menu.

---

### **8 USB Port**

Connect a USB Mass Storage Device to play photos, videos and audio files from the digital storage device.

---

### **9 Headphone Output**

Plug headphones into the Headphone Output to listen to audio through the headphones.

---

### **10 Easel**

Adjust and use the Easel to place the unit in landscape or portrait orientation.

---

### **11 Volume Buttons**

Press the Volume Buttons to adjust the volume of the unit, or to navigate the unit's menus.

---

### **12 Enter/Mode Button**

Press the Enter/Mode Button to make selections in the unit's menus, or to switch between the clock and calendar when in clock or calendar mode.

---

# Location of Controls

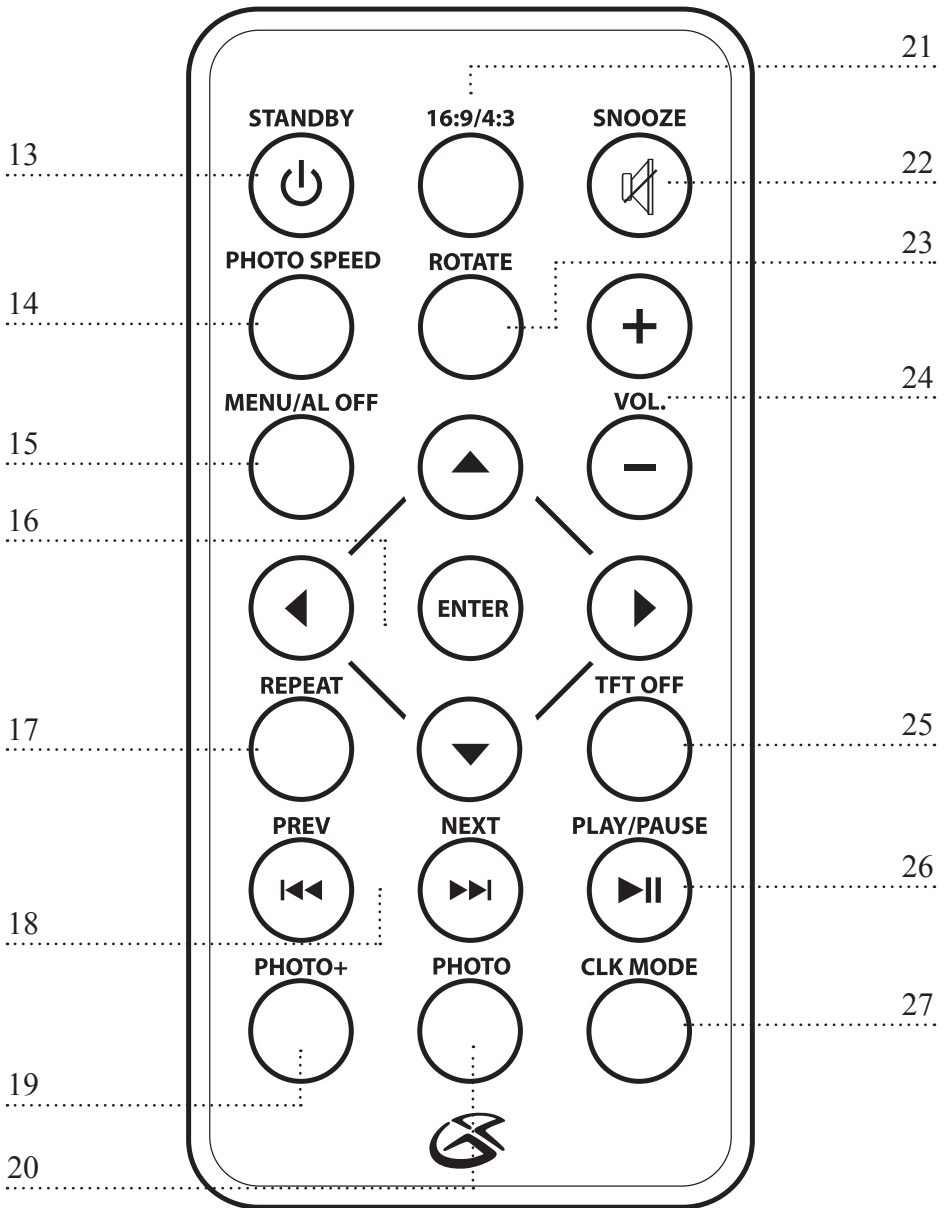

# Control Definitions

---

## **13 Standby Button**

Press the Standby Button to turn the unit off and on.

---

## **14 Photo Speed Button**

Press the Photo Speed Button to adjust the speed of the photo slideshow during play.

---

## **15 Menu/AL Off Button**

Press the Menu Button to go back to the Main Menu.

---

Press the AL Off Button to turn the alarm off after it sounds.

---

## **16 Directional & Enter Buttons**

Press the Directional & Enter Buttons to navigate through the unit's menus and make selections.

---

## **17 Repeat Button**

Press the Repeat Button to repeat tracks when listening to music.

---

## **18 PREV/NEXT Buttons**

Press the PREV/NEXT Buttons to skip to the previous and next JPEG photo or MP3 audio file.

---

## **19 Photo + Button**

Press the Photo + Button to access the Photo + mode and listen to music while viewing photos.

---

## **20 Photo Button**

Press the Photo Button to access the Photo mode.

---

## **21 16:9/4:3 Button**

Press the 16:9/4:3 Button to change the display ratio of the TFT Display.

---

## **22 Snooze Button**

After the alarm sounds, press the Snooze Button to delay the alarm for an additional 6 minutes. Press the Mute button to mute the audio sound.

---

## **23 Rotate Button**

Press the Rotate Button to rotate selected photos.

---

## **24 Volume Buttons**

Press the Volume Buttons to adjust the unit's volume.

---

## **25 TFT Off Button**

Press the TFT Off Button to turn the TFT Display off.

---

## **26 Play/Pause Button**

Press the Play/Pause Button to play or pause the unit while viewing a slide show or listening to music.

---

## **27 Clk Mode Button**

Press the Clk Mode Button to switch between clock and calendar viewing.

---



## Service Information

---

**Address** 2116 Carr Street, St. Louis MO, 63106

**Phone** 1-314-621-2881

**Fax** 1-314-588-1805

**Email** [prodinfo@gpx.com](mailto:prodinfo@gpx.com)

**Website** [www.gpx.com](http://www.gpx.com)

---

To download this Instruction Manual in English, Spanish, or French visit the Support section at [www.gpx.com](http://www.gpx.com).

Para descargar este manual de instrucción en inglés, español, o francés visite la sección de la ayuda en [www.gpx.com](http://www.gpx.com).

Pour télécharger ce manuel d'instruction en anglais, espagnol, ou le Français visitez la section de soutien à [www.gpx.com](http://www.gpx.com).

---